

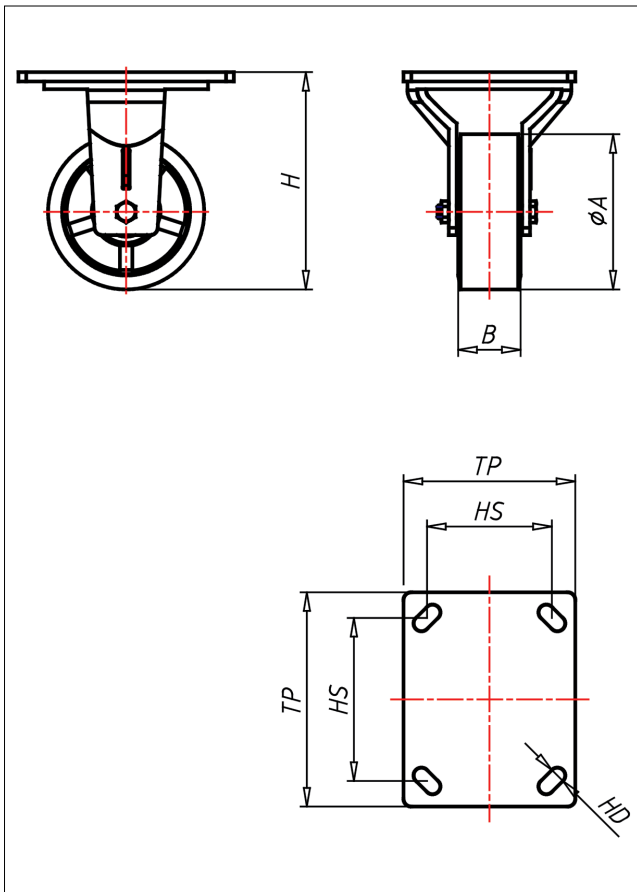

GTF-ZK/SUB/LZK

Bockrolle

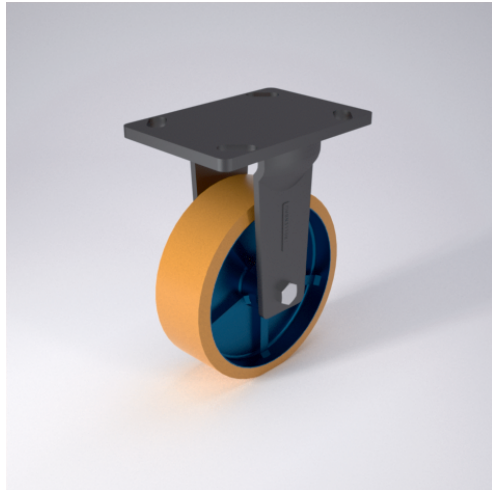

GT-SU



LENKROLLE	RADFESTSTELLER	BOCKROLLE
<ul style="list-style-type: none"> geräuscharmer Lauf geringer Rollwiderstand abrieb- und reißfest hohe Stoßfestigkeit sehr beständig gegen viele aggressive Medien <p>Guss-Polyurethan Felge Gusseisen lackiert → Seite 247</p>	<p>Schwerlastlenkgehäuse ohne Mittelbolzen mit gehärtetem Drehkranz und gehärteten Stahlkugeln, geschmiedet und getempert</p> <p>→ Seite 42</p>	<p>AUSWAHLHILFE:</p> <ul style="list-style-type: none"> leicht lenkend verschleißarm stoßfest bodenschonend witterungsbeständig

Technische Details

ORDERNO (Artikel-nummer)	GTF 150 ZK
WDAB (Rad-Ø A x Breite B / mm)	150x40
LC (Tragkraft / kg)	500
H (Bauhöhe H / mm)	200
TP (Plattengröße / mm)	150x105
HS (Lochabstand / mm)	105x80
HD (Loch-Ø / mm)	13
WB (Radlager)	Kugellager